



# Metropark

## Quick Start Overview

### Yealink T57W



# What's in the Yealink T57W box?

Phone



Ethernet Cable

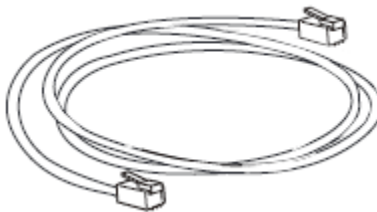

Handset Cable

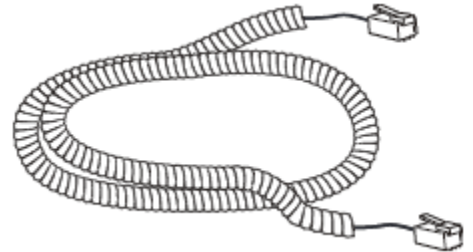

Handset

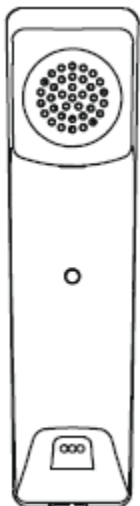

Stand

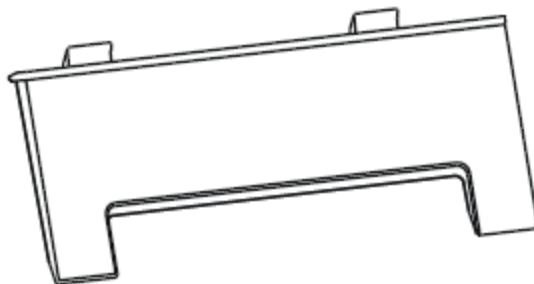

Power Adapter

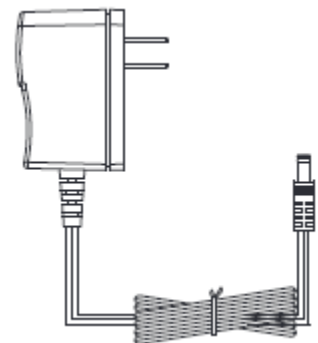

# Let's Start...

## Assembling Your Phone

Attach the stand, and adjust the angle of the screen, as shown below.

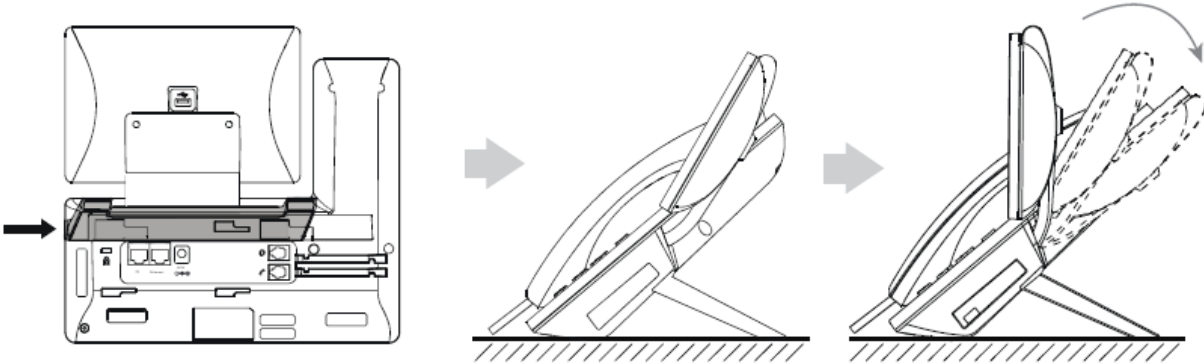

## Connect Handset and Optional Headset

**Note:** Your phone supports headsets using a RJ9 cable. For connection directions, refer to your headset documentation.

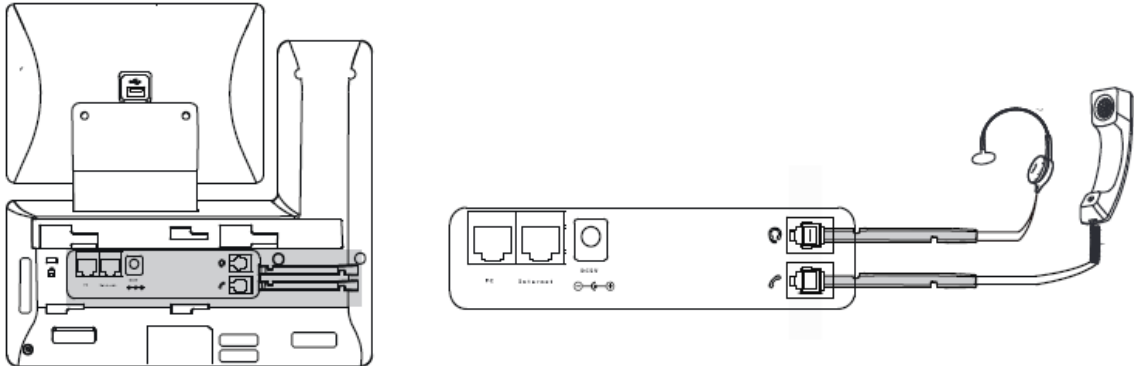

# Connect Cables

Please follow the diagram to install your phone. Once plugged in, the phone will automatically download its configuration and start to work. The voicemail box will be functional with a default greeting.

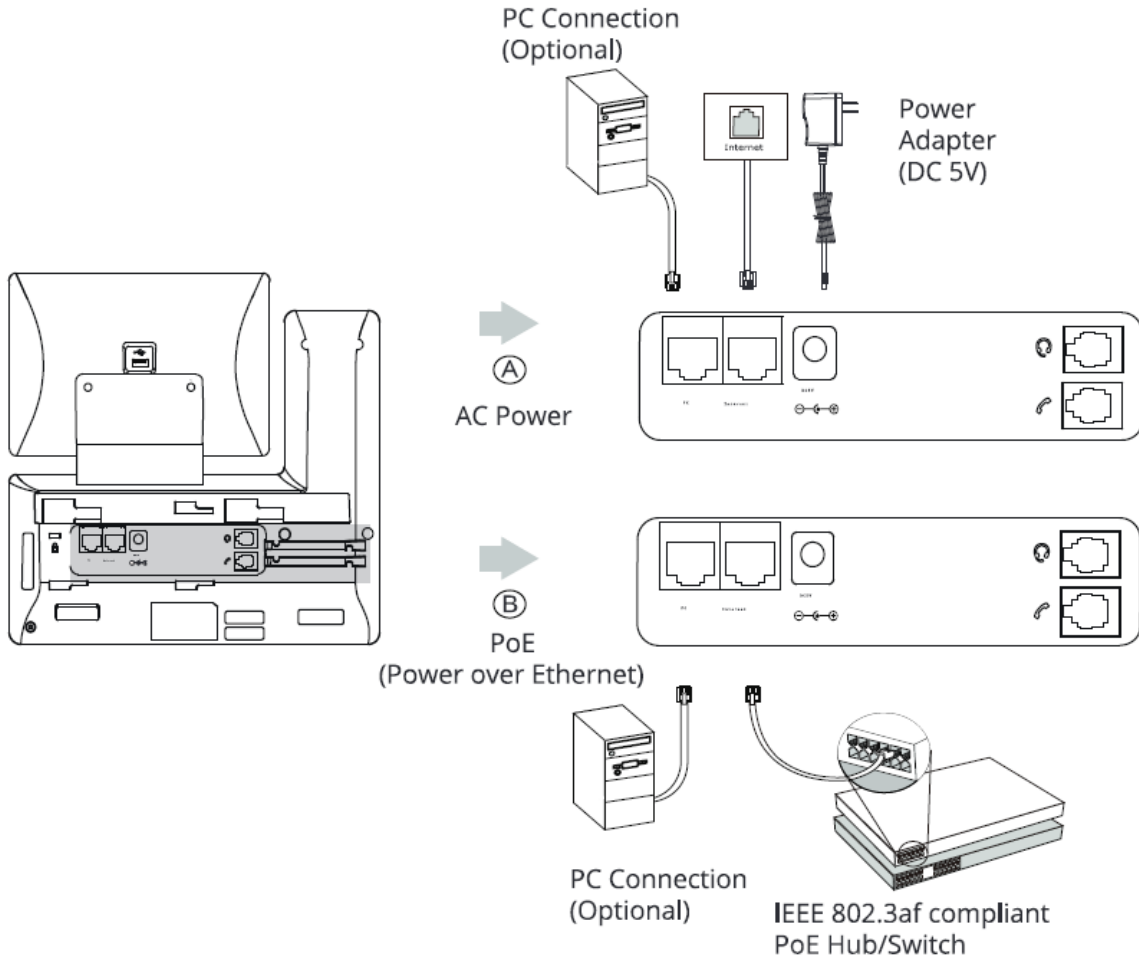

# Voicemail Setup

## **RECORDING YOUR PERSONAL VOICEMAIL GREETING**

1. Press the “Messages”  button.
2. Enter the PIN provided to you by your Administrator, followed by the # key.
3. Select option 5 for personal options.
4. Select option 1 to record your voicemail greeting.
5. Follow the voice prompts to record and check your greeting.

## **CHANGING THE PIN FROM THE PHONE**

1. Press the “Messages”  button.
2. Enter the PIN provided to you by your Administrator, followed by the # key.
3. Select option 5 for personal options.
4. Select option 3 to change your PIN.
5. Enter the new PIN when prompted. Press # when done.

# Common Features

## PLACING OUTGOING CALLS

When the phone is not in use:

1. Pick up the handset or press the "Speakerphone"  button.
2. Dial tone will be heard.

When using a headset:

1. Press the "Headset"  button to activate headset mode.
2. No dial tone will be heard; Dial an extension or telephone number.

When you are already on a call:

1. Press the "Hold" soft key.
2. Press the "NewCall" soft key.
3. Dial an extension or telephone number.
4. Resume the original call by pressing the "Resume" soft key.

## ANSWERING AN INCOMING CALL

On the Handset:

- Pick up the handset to answer the call.

On a Headset:

- When a headset is connected, press the "Headset"  button to answer the call.

On Speakerphone:

- Press the "Speaker"  button to answer the call.

## REJECTING AN INCOMING CALL

Press the “Reject” soft key to immediately send the caller to voicemail.

## IGNORING AN INCOMING CALL

Press the “Silence” soft key to ignore the incoming phone call.

**Note:** The caller will continue to hear ringing for the specified amount of time, defined in the phone’s “No Answer Forwarding” settings.

## ENDING A CALL

On a Handset:

- Hang up the handset or press the “More” soft key followed by the “EndCall” soft key.

On a Headset:

- Press the “More” soft key, followed by the “End Call” soft key.

On Speakerphone:

- Press the “Speakerphone” button.

## HOLD



Placing a Call On Hold:

- While on a call, press the “Hold” soft key.

Retrieving Calls On Hold:

- Press the “Resume” soft key.

## MUTE

1. To mute the microphone on an active call, press the “Mute”  button.
2. To un-mute the microphone, press the “Mute”  button again.

## VOICEMAIL

1. Press the “Envelope”  button.
2. Enter your PIN when prompted, followed by a #.

## **TRANSFERRING CALLS**

### **Blind Transfers:**

1. While on a call, press the "Transfer" soft key.
2. Dial the desired phone number or extension number.
3. Press the "Transfer" soft key again.
4. The call is automatically transferred.

### **Attended (Consultative or Warm) Transfers:**

1. While on a call, press the "Transfer" soft key.
2. Dial the desired phone number or extension number.
3. Wait for the party to answer to announce that you are transferring a call to them.
4. Press the "Transfer" soft key to transfer the call.

## **CALL WAITING**

While already on a call, and a new call rings in, you will hear a beep tone emitted by your phone.

### **To Answer the Second Call:**

1. Press the "Answer" soft key to access that call. The first call will be placed on hold.
2. Once the second call has ended, resume the original call by pressing the "Resume" soft key.

### **To Reject the Second Call:**

- Press the "Reject" soft key to immediately send the caller to voicemail.



## **VOLUME ADJUSTMENT**

### **In-Call Volume:**

- While on a call, press the "+" and "-"  buttons to raise or lower the volume.

### **Ringer Volume:**

- While the phone is not in use, press the "+" or "-"  buttons to adjust the ringer volume on the phone.

## **SPEAKERPHONE**

### **While the phone is not in use:**

- Press the "Speakerphone"  button to activate the speakerphone and get dial tone for an outbound call.

### **While on a call on the handset or headset:**

- Press the "Speakerphone"  button to continue the current call on the speakerphone.

### **While a call on speakerphone is active:**

- Press the "Speakerphone"  button to hang up the current call.

## **FORWARDING CALLS**

1. Press the "Menu" soft key.
2. Press the down arrow key to highlight "Features" and press the "Ok" button.
3. Press the "Ok" button while highlighting "Call Forward".
4. Press the "Ok" button or the "Enter" soft key.
5. If "Always Forward" is currently disabled, "Always Forward: Off" will be displayed.
6. Press the "Ok" button, followed by the left or right "Arrow" button to enable always forwarding, then press the "Save" soft key.
7. Enter a valid telephone number or extension.
8. Press the "Ok" button or the "Save" soft key.

### Disabling "Always Forward":

1. If "Always Forward" is currently enabled, "Always Forward: On" will be displayed.
2. Press the "Ok" button or the "Enter" soft key.
3. Use the left or right "Arrow" button to disable always forwarding.
4. Press the "Ok" button or the "Save" soft key.

"Busy Forward" and "No Answer Forward" can be set in a similar manner.



# **Metropark**

## Support Contact Information

**(314) 439-1900 #1**

**(877) 900-6856 #1**

**support@metropark.com**